



PROJECT	DATE
TYPE	CATALOG #

PITCHED PATH AP-310B

KEY FEATURES

- CONTEMPORARY DESIGN
- SOLID BRASS
- REFLECTIVE WHITE COATING FOR MAXIMUM LIGHT OUTPUT
- UV PROTECTED FROSTED ACRYLIC LENS
- HIGH TEMPERATURE SOCKET
- FIELD REPLACEABLE LED

PRODUCT SPECIFICATION

DIMENSIONS	22"H X 6-1/4"W X 1" SQUARE TUBING
LENS	FROSTED ACRYLIC
SOCKET	BI PIN
LAMP	ENCAPSULATED T3/G4
VOLTAGE	9-18V AC/DC
LIGHT SPREAD	6-8 FT AVG

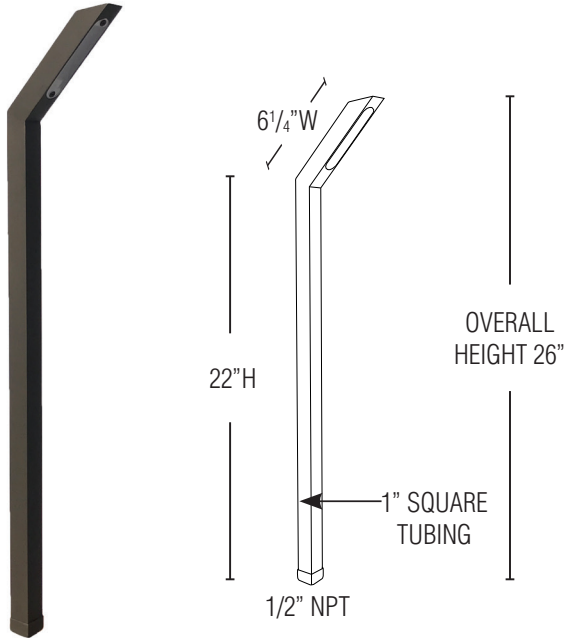

STEP 1

FIXTURE CONFIGURATION

AP-310B 



FINISH OPTION 

NBZ NATURAL BRONZE

SS STAINLESS STEEL

STEP 2

LED LAMP CONFIGURATION

LED-T3   

LED WATTAGE 

1.5W 110 LM

2.5W 210 LM

3.5W 280 LM

KELVIN TEMPERATURE 

27K 2700K

30K 3000K

ENCAPSULATED 

ENC ENCAPSULATED (IP67)

STEP 3

ACCESSORY OPTIONS

AX-801P 

INCLUDED

STAKE OPTION 

AX-801P LARGE SLOTTED STAKE

AX-802P HEAVY DUTY PERMA POST